

Low voltage AC drives for HVAC applications

# ***FRENIC-HVAC***

## ***Smile to the Environment***



# VAC

High performance enabled by the comprehensive use of Fuji technology.  
Easy maintenance for the end-user. Maintains safety and protects the  
environment. Opens up possibilities for the new generation.



# Smile to the Environment **FRENIC-HVAC**

~ Energy Saving for the environment and our children's future ~

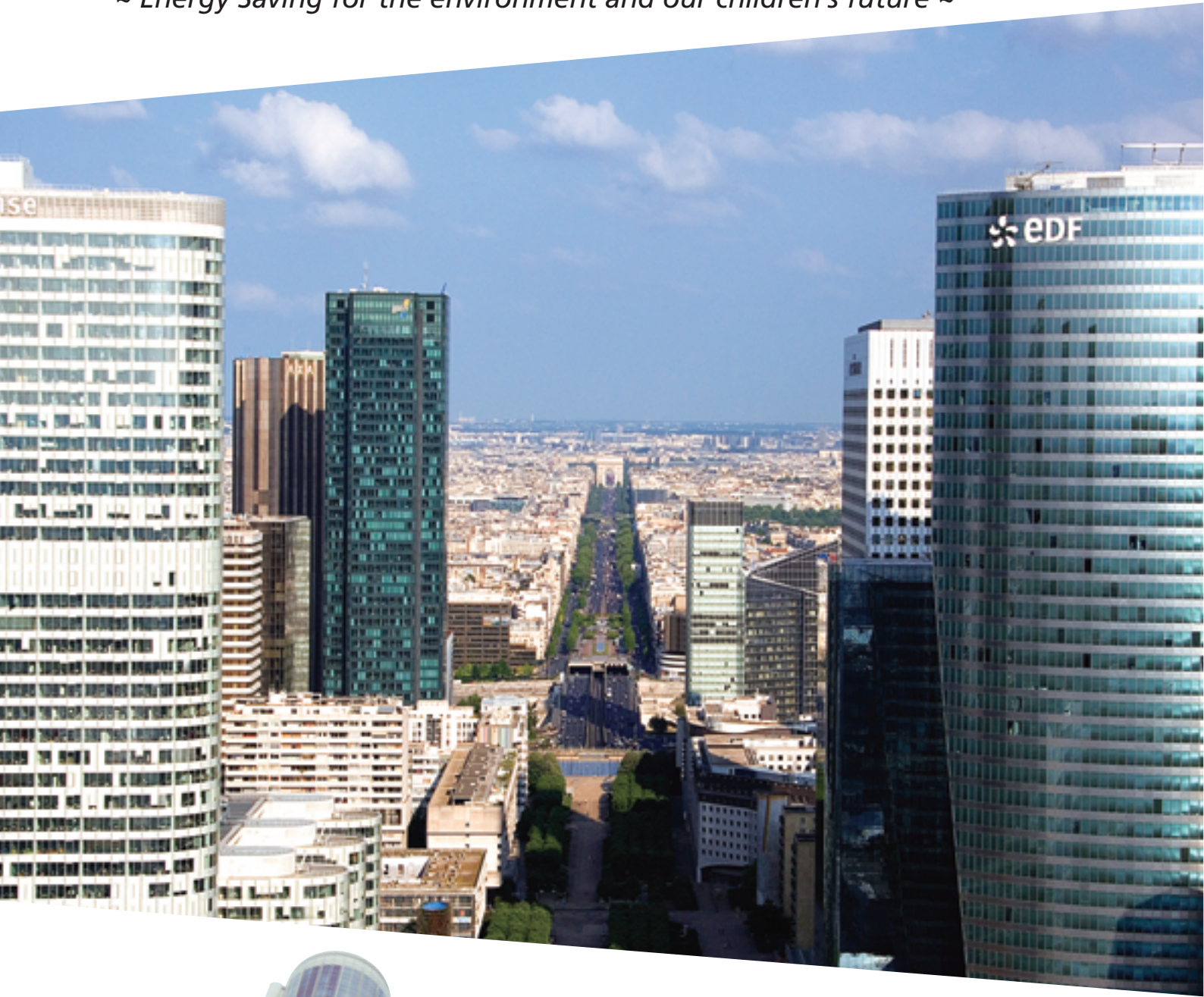

**The first slim-type inverter specialized in energy-saving from Fuji Electric.  
Achieves a great effect on energy-saving of fans and pumps!  
Contributes drastically to cost reduction by cutting power consumption!**

The energy consumed in fans and pumps for HVAC operation can be significantly saved by using inverters. To achieve this purpose, the market demands higher functionality and performance to inverters. The FRENIC-HVAC series, Fuji Electric's new product, controls water and air flow rates, pressure, and temperature with the fan and pump optimally, contributing a lot to saving electricity and cost reduction achieved by energy saving.





## Large Contribution to Reducing Global Warming (Environmental Protection) with Energy Saving

50% of energy consumption in office buildings is related to air conditioning. The FRENIC HVAC series is the dedicated inverter for HVAC that features functions and performances offer the optimal thermal environment for the people working in the building by keeping the energy consumption in various devices (compressor, condenser water pump, AHU and others) to the minimum. Fuji Electric contributes largely to global environment by realizing carbon dioxide reduction with energy saving by the inverter.

### Wide variation in model capacity

Model can be selected from two model types.

#### ■ Standard type (EMC filter built-in type)

0.75 to 710kW (Protective structure IP21 or IP55 can be selected with the model between 0.75 and 90kW.)

#### ■ DCR built-in + EMC filter built-in type

0.75 to 90kW (Protective structure IP21 or IP55 can be selected with the model between 0.75 and 90kW.)

Inverter capacity	EMC filter	DC reactor	Protective structure
0.75kW to 90kW	Built-in	Built-in	IP21/IP55
110kW to 710kW	Built-in	External	IP00

\* The models with inverter capacity 45kW to 710kW are coming soon.

### Optimal control with energy-saving function

- Linearization function
- Temperature difference constant control and pressure difference constant control
- Energy saving functions including wet-bulb temperature presumption control
- Automatic energy-saving operation

### Slim body

The first slim body design among the Fuji Electric inverters.

The size is the same between IP21 and IP55 (the first in the industry).

### Functions suitable for HVAC use

- 4PID control
- Fire mode (forced operation)
- Pick-up operation function
- Real time clock
- Torque vector control
- Filter clogging prevention function
- Customized logic
- User friendly, useful keypad
- Password function

### Stand alone

- The inverter can be installed independently; no control panel is required.



# Significant Energy Saving Realized!!

For an air-conditioning heat source system, the needed quantity of the cooling or heating water fluctuates generally in seasons or days and nights. Therefore, operations continuing in a water conveyance pressure constant control may lead to high operating unnecessary pressures on terminals at low operating state. Thus, the pump consumes an ineffectual electric power for maintaining the high water conveyance pressure.

FRENIC-HVAC can perform an estimated terminal pressure control by linearization function which estimates target pressure from load flow rate.

It is possible to reduce the ineffectual pump power consumption and to achieve a great energy-saving effect together with maintaining comfortable current air conditioning.

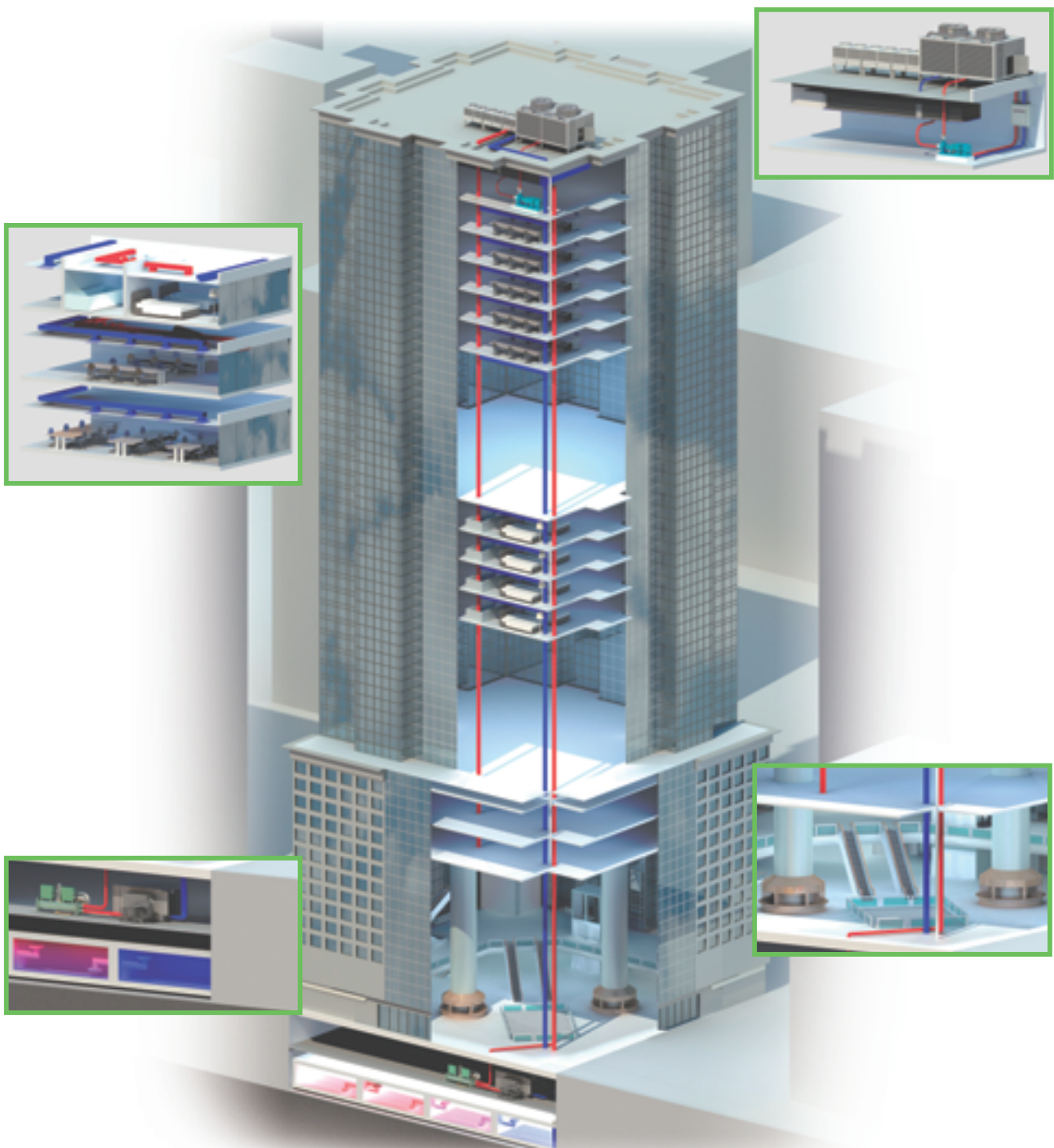

## Optimum Control for HVAC Facilities

### • Cooling tower fan

The cooling tower fan is used to cool the heat of cooling water by emitting it into the air. The fan speed is adjusted optimally according to the cooling water temperature at the outlet. Moreover, the inverter estimates the wet-bulb temperature automatically to control the fan so that the temperature of cooling water (wet bulb) is interlocked to the air temperature. (Wet-bulb temperature presumption control)



### • Cooling water pump

The cooling water pump circulates the cooling water to the cooling tower in order to cool the heat generated by the Refrigeration machine. The pump speed is adjusted optimally according to the temperature and flow rate of cooling water. Moreover, the inverter can control the cooling pump so that the difference of cooling water temperature at between the inlet and outlet becomes always constant. (Temperature difference constant control)



### • Chilled water pump

The chilled water pump circulates the chilled water generated with the Refrigeration machine to the air conditioner and fan coil. The pump speed is adjusted optimally according to the header pressure. Moreover, the pump conveyance pressure can be controlled to proper value by converting the flow rate signal to the target pressure using the linearization function. (Linearization function)



### • Supply fan / Return fan

The speed of supply and return fans is adjusted optimally according to the pressure, discharge temperature, room temperature, and others. Moreover, the highest level of carbon dioxide is selected automatically by detecting the level in room to control it to stay within the allowable level.

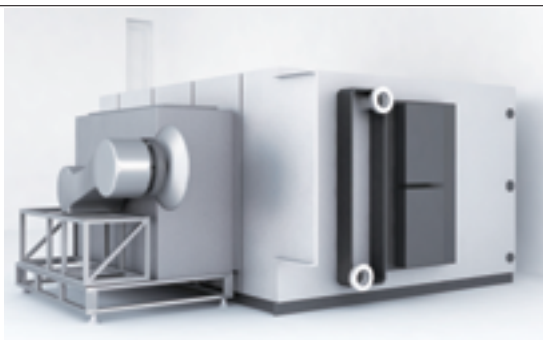

# Optimal Structure Design

## User friendly, easy to see keypad

- The regulator is indicated by enlarging the LCD.

- |                            |                   |                       |
|----------------------------|-------------------|-----------------------|
| 1. Present value (PV)      | 5. Output current | 9. Power consumption  |
| 2. Setting value (SV)      | 6. Output voltage | 10. Cumulative energy |
| 3. Manipulating value (MV) | 7. Torque         |                       |
| 4. Frequency               | 8. Rotation speed |                       |



\*Possible to show understandable indications through the unit conversion function.  
 \*Multi-language function: 19 languages + user customized language supported

- Multi-language supported: 19 languages + user customized language (Planned)

Language				
Japanese	English	Chinese	German	French
Spanish	Italian	Russian	Greek	Turkish
Malay	Vietnamese	Thai	Indonesian	Polish
Czech	Swedish	Portuguese	Dutch	

## Real time clock (RTC) is provided as standard.

- Alarm information with date and time

- Alarm information for last ten times is stored and displayed with date and time.

*Easy failure analysis*

- Timer function

- Possible to set the maximum four timers for a week.
- Possible to set flag holidays (20 days a year).

*Operation schedule can be set according to actual condition by using four timers.*

### Example

When operation is performed in the same schedule through a week

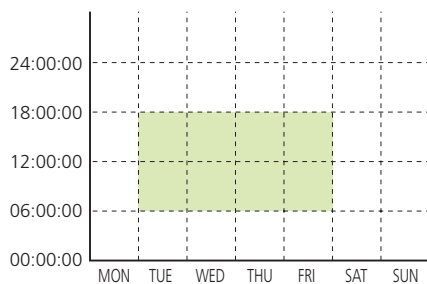

When operation schedule varies depending on the day of the week

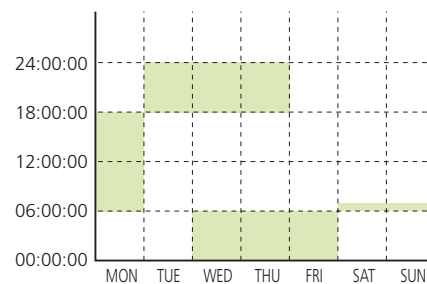

- Unit conversion function between PV and SV values

- Unit conversion allows you to easily set data.

Function	Units			
Unit conversion	No conversion	%	RPM	l/min
	m <sup>3</sup> /h	°C	mbar	bar
	kPa	mWG	mmHg	kW
	in-wg	psi	°F	ppm
	PSI			



**1 User-friendly, easy to see dedicated keypad**

Multi-language supported, HELP function featured, unit setting with SV and PV values, data copy (three kinds), detachable and can be attached on the panel (using an optional cable)

**4 Capacitor board**

Outputs the life prediction signal determining capacitor capacity drop and cumulative running hours. This allows the user to grasp replacement period.

**5 Cooling fan**

Easy replacement just by simply removing and attaching the part. Life prolongation is possible by controlling ON and OFF.

**3 Control terminal block**

The detachable control terminal block is adopted. This allows the unit to be replaced easily without disconnecting cables.

**2 Control board**

USB port equipped, BACnet equipped as standard.  
Max. three types of built-in optional boards can be mounted all together.  
Optional battery connection  
Various communications options

**6 EMC filter**

Drastically reduces noise. Provided to units of all capacities. Conforming to IEC61800-3.

**7 DCR**

Drastically reduces harmonic noise. Conforming to IEC/EN61000-3-2 and IEC/EN61000-3-12. Provided as standard (to models up to 90kW), and can be attached externally as an option (to models from 110kW to 710kW).

**8 Environmental immunity**

3C2, IEC60721-3-3 supported

**9 Others**

Support/analysis software by loader, RTC backup by battery (option)

Standard equipment	Optional equipment
<ul style="list-style-type: none"> <li>• BACnet MS/TP</li> <li>• Modbus RTU</li> <li>• Metasys N2</li> </ul>	<ul style="list-style-type: none"> <li>• LonWorks</li> <li>• Ethernet</li> <li>• Profi bus</li> <li>• DeviceNet</li> <li>• CANopen</li> <li>• CC-Link</li> </ul>

# Functions Suitable for HVAC Use

## Linearization function

This function estimates the target pressure using the load flow rate, which allows the estimated terminal pressure to be controlled.

For an air-conditioning heat source system, the needed quantity of the cooling or heating water fluctuates generally in seasons or days and nights. Therefore, operations continuing in a water conveyance pressure constant control may lead to high operating unnecessary pressures on terminals at low operating state. Thus, the pump consumes an ineffectual electric power for maintaining the high water conveyance pressure.

Based on the calculated value and water conveyance pressure of estimated terminal pressure using the detected load flow rate, PID control is performed.

It is possible to reduce the ineffectual pump power consumption and to achieve a great energy-saving effect together with maintaining comfortable current air conditioning.

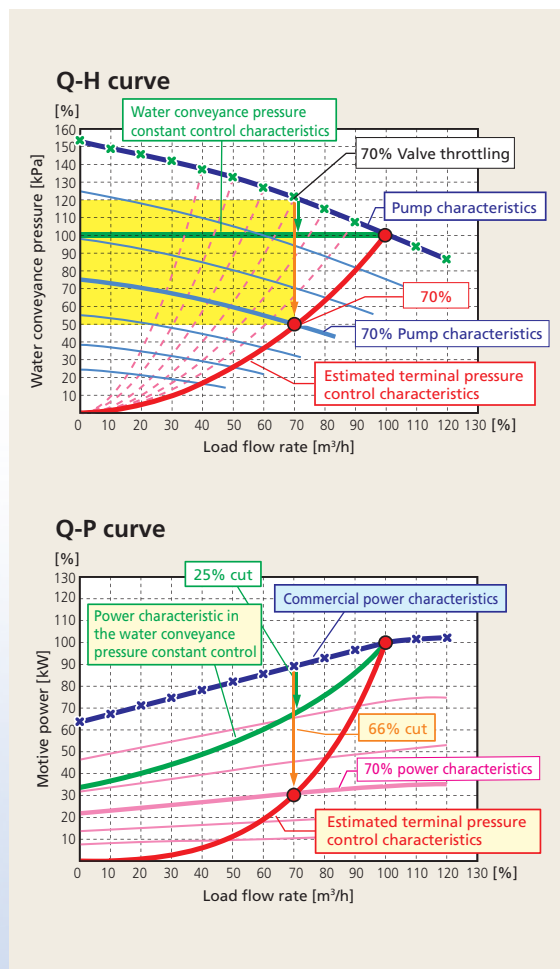
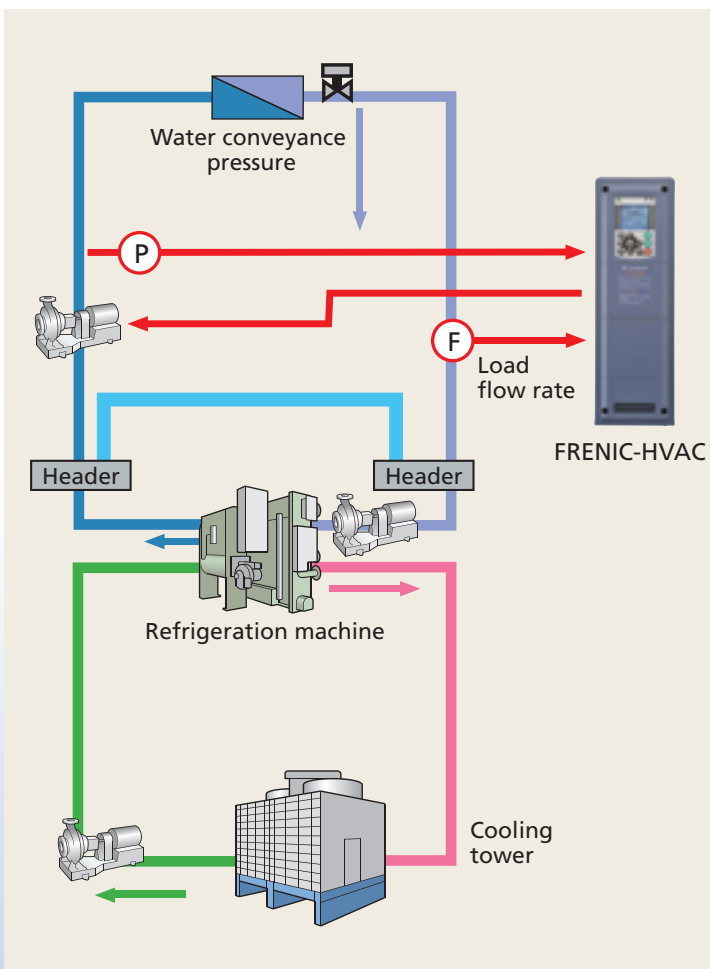



## Wet-bulb temperature presumption control

This function is optimal for controlling the fan of cooling tower. Since the wet-bulb temperature would become higher than the set temperature when the air temperature is particularly high, water temperature will not reach the set temperature. Therefore, the fan keeps rotating at high speed, failing in energy-saving operation. FRENIC-HVAC automatically estimates the wet-bulb temperature and controls the fan so that the cooling water is interlocked with the air temperature in order not to use unnecessary electric power.

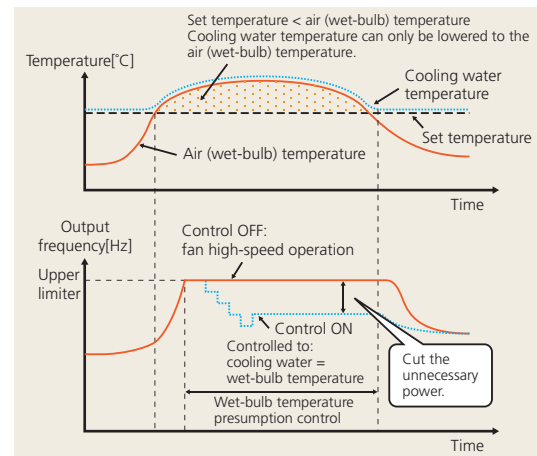

## Filter clogging prevention function

This function detects clogging of the fan filter with dust or other materials using the output current and pressure sensor value. When clogging is detected, the fan is rotated in reverse to eject dust, and then resumes rotation in forward to blow air. In addition, the function notifies you of maintenance necessity with the alarm signal.

## Customized logic

The customized logic interface function is provided to the inverter body. This enables forming of logic circuit and arithmetic circuit to the digital and analog input and output signals, allowing simple relay sequence to be built while processing the signals freely.

Example

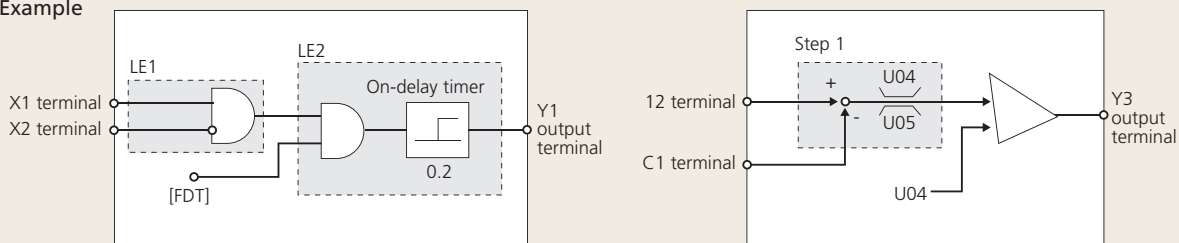

## Standard 4PID control

The 4PID control is featured as standard. One PID module is used to control the output frequency of the inverter, and the other three PIDs can be used to control the external system. To utilize all of four PIDs, the optional card (OPC-AIO) needs to be mounted.

## Password

Function codes can be read/write, displayed or hidden by setting the two passwords. This prevents erroneous operation or overwriting of function codes. In addition, if a wrong password was input exceeding the specified number of times, the inverter is restricted from operating as the user is regarded as improper.

## Fire mode (forced operation)

This mode ignores (retry) the inverter protection function to continue the operation. In that way, the inverter keeps operating the fan and pump as much as possible in case of emergency such as fire.

## Pick-up operation function

The pick-up operation function enables smooth starts. If you wish to run a fan currently not run by the inverter and in idle mode, this function searches the speed regardless of the direction of rotation and pick up the motion smoothly. This function allows for smooth operation such as when switching the power supply from the commercial power to inverter in a momentary action.

# Standard Specifications

## 3-phase, 400V series (0.75 to 55kW)

Item		Specifications													
Type	FRN □□□□ AR1 □-4A : HVAC	0.75	1.5	2.2	3.7	5.5	7.5	11	15	18.5	22	30	37	45	55
	FRN □□□□ AR1 □-4E : HVAC	0.75	1.5	2.2	4.0	5.5	7.5	11	15	18.5	22	30	37	45	55
Nominal applied motor (Rated output) [kW] *1		0.75	1.5	2.2	3.7/4.0	5.5	7.5	11	15	18.5	22	30	37	45	55
Output ratings	Rated capacity [kVA] *2	1.9	3.1	4.1	6.8	10	14	18	24	29	34	45	57	69	85
	Rated voltage [V] *3	Three-phase, 380 to 480 V (with AVR function)													
	Rated current [A]	2.5	4.1	5.5	9.0	13.5	18.5	24.5	32	39	45	60	75	91	112
	Overload capability	110% - 1 min (Overload capability interval : IEC 61800-2 compliant)													
	Rated frequency [Hz]	50, 60Hz													
Input ratings	Main circuit power input : Phases, voltage, frequency	Three-phase, 380 to 480 V, 50/60 Hz												Three-phase, 380 - 440 V, 50 Hz Three-phase, 380 - 480 V, 60 Hz	
	Auxiliary control power input : Phases, voltage, frequency	Single-phase 380 to 480 V, 50/60 Hz													
	Auxiliary power input for main circuit : Phases, voltage, frequency *4	-													
	Voltage, frequency variations	Voltage: +10 to -15% (Interphase voltage unbalance : 2% or less) *5, Frequency: +5 to -5%													
	Rated current [A] *6	1.6	3.0	4.3	7.4	10.3	13.9	20.7	27.9	34.5	41.1	55.7	69.4	83.1	102
Required power supply capacity [kVA]	1.2	2.1	3.0	5.2	7.2	9.7	15	20	24	29	39	49	58	71	
Braking	Torque [%] *7	20										10 to 15			
	DC injection braking	Starting frequency:0.0 to 60.0Hz, Braking time:0.0 to 30.0s, Braking level:0 to 60%													
EMC filter (IEC/EN 61800-3:2004)		EMC standards compliance : Category C2 (emission) / 2nd Env. (Immunity)													
DC reactor (DCR)		Built-in (IEC/EN 61000-3-2, IEC/EN 61000-3-12)													
Power factor(at rated load)	Displacement P.F. (cosφ)	>0.98													
	True P.F.	≥0.90													
Efficiency (at rated load)		95%	96%				97%								
Applicable safety standards		UL508C, IEC/EN 61800-5-1:2007													
Enclosure (IEC/EN 60529)		IP21/IP55													
Cooling method		Fan cooling													
Weight/Mass [kg]	IP21	10	10	10	10	10	10	18	18	18	18	23	23	50	50
	IP55	10	10	10	10	10	10	18	18	18	18	23	23	50	50

## 3-phase, 400V series (75 to 710kW)

Item		Specifications													
Type	FRN □□□□ AR1 □-4A : HVAC	75	90	110	132	160	200	220	280	315	355	400	500	630	710
	FRN □□□□ AR1 □-4E : HVAC	75	90	110	132	160	200	220	280	315	355	400	500	630	710
Nominal applied motor (Rated output) [kW] *1		75	90	110	132	160	200	220	280	315	355	400	500	630	710
Output ratings	Rated capacity [kVA] *2	114	134	160	192	231	287	316	396	445	495	563	731	891	1044
	Rated voltage [V] *3	Three-phase, 380 to 480 V (with AVR function)													
	Rated current [A]	150	176	210	253	304	377	415	520	585	650	740	960	1170	1370
	Overload capability	110% - 1 min (Overload capability interval : IEC 61800-2 compliant)													
	Rated frequency [Hz]	50, 60Hz													
Input ratings	Main circuit power input : Phases, voltage, frequency	Three-phase, 380 to 440 V, 50 Hz							Three-phase, 380 to 480 V, 60 Hz						
	Auxiliary control power input : Phases, voltage, frequency	Single-phase 380 to 480 V, 50/60 Hz													
	Auxiliary power input for main circuit : Phases, voltage, frequency *4	Single-phase 380 to 440 V, 50 Hz							Single-phase 380 to 480 V, 60 Hz						
	Voltage, frequency variations	Voltage: +10 to -15% (Interphase voltage unbalance : 2% or less) *5, Frequency: +5 to -5%													
	Rated current [A] *6	136	162	201	238	286	357	390	500	559	628	705	881	1115	1256
Required power supply capacity [kVA]	95	113	140	165	199	248	271	347	388	436	489	611	773	871	
Braking	Torque [%] *7	10~15													
	DC injection braking	Starting frequency:0.0 to 60.0Hz, Braking time:0.0 to 30.0s, Braking level:0 to 60%													
EMC filter (IEC/EN 61800-3:2004)		C2/2nd.		EMC standards compliance : Category C3 (emission) / 2nd Env. (Immunity)											
DC reactor (DCR)		Built-in (IEC/EN 61000-3-2, IEC/EN 61000-3-12)		Standard accessory (IEC/EN 61000-3-2, IEC/EN 61000-3-12)											
Power factor(at rated load)	Displacement P.F. (cosφ)	>0.98													
	True P.F.	≥0.90													
Efficiency (at rated load)		97%				98%									
Applicable safety standards		UL508C, IEC/EN 61800-5-1:2007													
Enclosure (IEC/EN 60529)		IP21/IP55				IP00									
Cooling method		Fan cooling													
Weight/Mass [kg]	IP21	70	70												
	IP55	70	70												
	IP00	-	62	64	94	98	129	140	245	245	245	330	530	530	

\*1) Fuji 4-pole standard motor.

\*2) Rated capacity is calculated by assuming the output rated voltage as 440 V.

\*3) Output voltage cannot exceed the power supply voltage.



\*4) The auxiliary power input is used as an AC power input when combining the unit to DC power supply such as high power factor PWM converter with power regenerative function. (Generally not to be used.)

\*5) Voltage unbalance [%] = (Max. voltage [V] - Min. voltage [V])/Three-phase average voltage [V] x 67 (See IEC61800-3).  
If this value is 2 to 3%, use an optional AC reactor (ACR).

\*6) The value is calculated on assumption that the inverter is connected with a power supply 400V, 50Hz and Rsc=120.

\*7) Average braking torque for the motor running alone. (It varies with the efficiency of the motor.)



# Common Specifications

Items		Specifications	Remarks
Output	Maximum frequency	• 25 to 120 Hz	
	Base frequency	• 25 to 120 Hz variable setting	
	Starting frequency	• 0.1 to 60.0 Hz variable setting	
	Carrier frequency	<ul style="list-style-type: none"> <li>• 0.75 to 16 kHz variable setting (0.75 kW to 37 kW)</li> <li>• 0.75 to 10 kHz variable setting (45 kW to 90 kW)</li> <li>• 0.75 to 6 kHz variable setting (110 kW to 630 kW)</li> <li>• 0.75 to 4 kHz variable setting (710 kW)</li> </ul> NOTE: Frequency drops automatically to protect the inverter depending on environmental temperature and output current. (This auto drop function can be canceled.)	
		Output frequency Accuracy (Stability)	<ul style="list-style-type: none"> <li>• Analog setting : <math>\pm 0.2\%</math> of max. frequency (at <math>25 \pm 10</math> )</li> <li>• Digital setting : <math>\pm 0.01\%</math> of max. frequency (at -10 to +50 )</li> </ul>
	Setting resolution	<ul style="list-style-type: none"> <li>• Analog setting : 1/3000 of max. frequency (1/1500 with [V2] input)</li> <li>• Digital setting : 0.01 Hz (99.99 Hz or less), 0.1Hz (100.0 to 120 Hz)</li> <li>• Link setting : 1/20000 of max. frequency or 0.01 Hz (fixed)</li> </ul>	
Control	Control method	<ul style="list-style-type: none"> <li>• V/f control</li> <li>• Dynamic torque vector control</li> <li>• V/f control, the slip compensation is available.</li> </ul>	
	Voltage/frequency characteristic	<ul style="list-style-type: none"> <li>• Base frequency and max. output frequency can be set to 160 to 500V in common.</li> <li>• The AVR control ON/OFF can be selected.</li> <li>• Non-linear V/f setting (3 points) : Free voltage (0 to 500 V) and frequency (0 to 120 Hz) can be set.</li> </ul>	
	Torque boost	<ul style="list-style-type: none"> <li>• Auto torque boost</li> <li>• Manual torque boost : Desired torque boost (0.0 to 20.0%) can be set.</li> <li>• Select application load with function code.(Constant torque load or variable torque load)</li> </ul>	
	Starting torque	<ul style="list-style-type: none"> <li>• 100% or higher/set frequency : 1.0 Hz</li> <li>• Base frequency 50 Hz, Slip compensation and auto torque boost operation</li> </ul>	
	Start/stop operation	<ul style="list-style-type: none"> <li>• Keypad : Start and stop with <b>FWD</b>, <b>REV</b> and <b>STOP</b> keys.</li> <li>• External signals (digital inputs) : Forward (Reverse) rotation, stop command (capable of 3-wire operation), coast-to-stop command, external alarm, alarm reset, etc.</li> <li>• Link operation : Operation through RS-485 or field bus (option) communications.</li> <li>• Switching operation command : Remote/Local switching, link switching.</li> </ul>	
		Frequency setting	<ul style="list-style-type: none"> <li>• Keypad : Can be set with  and  keys.</li> <li>• External Volume : Can be Set with external potentiometer (1 to 5k<math>\Omega</math> 1/2W).</li> <li>• Analog input : 0 to <math>\pm 10</math> VDC (<math>\pm 5</math> VDC)/0 to <math>\pm 100\%</math> (Terminals [12] and [V2]) 0 to +10 VDC (+5 VDC)/0 to +100% (Terminals [12] and [V2]) +4 to +20 mADC/0 to 100% (Terminal [C1]) 0 to +20 mADC/0 to 100% (Terminal [C1])</li> <li>• UP/DOWN operation : Frequency can be increased or decreased while the digital input signal is ON.</li> <li>• Multi-frequency : Selectable from 16 steps (step 0 to 15).</li> <li>• Link operation : Frequency can be set via RS-485 (Standard accessory).</li> <li>• Switching frequency setting : Frequency setting can be switched (2 settings) by external signal (digital input). Remote/local switching, link switching.</li> <li>• Auxiliary frequency setting : Terminal [12],[C1] or [V2] input can be selected respectively as an additional input.</li> <li>• Inverse operation : The setting "0 to +10 VDC/0 to 100%" can be switched to "+10 to 0 VDC/0 to 100%" by external command. The setting "+4 to +20 mADC/0 to 100%" can be switched to "+20 to +4 mADC/0 to 100%" by external command. The setting "0 to +20 mADC/0 to 100%" can be switched to "+20 to 0 mADC/0 to 100%" by external command.</li> <li>• Programmed PATTERN operation : Maximum 7 stages can be set.</li> </ul>
	Acceleration/ deceleration time	<ul style="list-style-type: none"> <li>• Setting range : 0.00 to 3600 s</li> <li>• Switch : The four types of accel./decel. time can be set or selected individually. (switchable during operation)</li> <li>• Acceleration/deceleration pattern : Linear accel./decel., S-shape accel./decel. (weak, strong), curvilinear accel./decel. (accel./decel. max. capacity of constant output)</li> <li>• Deceleration mode (coast-to-stop) : Coast-to-stop at the operation command OFF.</li> <li>• Forcible stop decel. time : Deceleration stop by the forcible stop .</li> </ul>	
	Frequency limiter (Upper limit and lower limit frequencies)	<ul style="list-style-type: none"> <li>• Both upper and lower limit frequencies can be variably set in hertz.</li> <li>• It is possible to choose the operation done from continuous operation at lower limit frequency or operation stop when the set frequency drops below the lower limit.</li> </ul>	
	Bias frequency	<ul style="list-style-type: none"> <li>• Bias of set reference frequency and PID command can be independently set. (setting range : 0 to <math>\pm 100\%</math>)</li> </ul>	
	Analog input	<ul style="list-style-type: none"> <li>• Gain : Setting in the range from 0 to 200%.</li> <li>• Off-set: Setting in the range from -5.0 to +5.0%.</li> <li>• Filter : Setting in the range from 0.00s to 5.00s.</li> </ul>	
	Jump frequency	<ul style="list-style-type: none"> <li>• Actuation points (3 points) and their common jump widths (0 to 30 Hz) can be set.</li> <li>• Resonance points can be detected automatically and be set the jump frequency automatically.</li> </ul>	
	Auto-restart after momentary power failure	<ul style="list-style-type: none"> <li>• Trip at power failure : The inverter trips immediately after power failure.</li> <li>• Trip at power recovery : Coast-to-stop at power failure and trip at power recovery.</li> <li>• Continuous operation : Operation is continued using the load inertia energy.</li> <li>• Start at the frequency selected before momentary stop : Coast-to-stop at power failure and start after power recovery at the frequency selected before momentary stop.</li> <li>• Start at starting frequency : Coast-to-stop at power failure and start at the starting frequency after power recovery.</li> </ul>	
	Current limit by hardware	<ul style="list-style-type: none"> <li>• Limiting the current by hardware to prevent overcurrent trip due to sharp load change or momentary power failure which cannot be controlled by software current limit. (This function can be cancelled.)</li> </ul>	
	Operation by commercial power supply	<ul style="list-style-type: none"> <li>• With commercial power switching command, the inverter outputs 50Hz/60 Hz (SW50, SW60).</li> <li>• The inverter has the commercial power supply switching sequence.</li> </ul>	
	Slip compensation	<ul style="list-style-type: none"> <li>• Compensates for decrease in speed according to the load.</li> </ul>	
	Torque limiter	<ul style="list-style-type: none"> <li>• Switchable between 1st or 2nd torque limit values.</li> </ul>	
Current control (software current limit)	<ul style="list-style-type: none"> <li>• Automatically reduces the frequency so that the output current becomes lower than the preset operation level.</li> </ul>		



# Common Specifications

	Items	Specifications	Remarks
Control	PID control	<ul style="list-style-type: none"> <li>• PID adjuster for process control</li> <li>• PID command : Keypad panel, analog input (from terminals [12],[C1],[V2]), RS-485 communications</li> <li>• PID feedback value : Analog input (from terminals [12],[C1],[V2])</li> <li>• PV level detection</li> <li>• PV value conversion/calculation of analog input</li> <li>• PID output limiter</li> <li>• Integration reset/hold</li> <li>• Antireset windup</li> <li>• PID auto tuning</li> </ul>	
	Auto search for idling motor speed	<ul style="list-style-type: none"> <li>• Estimates the speed of the motor running under no load and starts the motor without stopping it. (Motor electric constant needs tuning : Offline tuning)</li> </ul>	
	Automatic deceleration	<ul style="list-style-type: none"> <li>• If the DC link voltage or calculated torque exceeds the automatic deceleration level during deceleration, the inverter automatically prolongs the deceleration time to avoid overvoltage trip. (It is possible to select forcible deceleration actuated with more than three times longer deceleration.)</li> <li>• If the calculated torque exceeds automatic deceleration level during constant speed operation, the inverter avoids overvoltage trip by increasing the frequency.</li> <li>• Automatic deceleration level can be set.</li> </ul>	
	Deceleration characteristic (improving braking ability)	<ul style="list-style-type: none"> <li>• The motor loss is increased during deceleration to reduce the regenerative energy in the inverter to avoid overvoltage trip.</li> </ul>	
	Automatic energy saving operation	<ul style="list-style-type: none"> <li>• The output voltage is controlled to minimize the total sum of the motor loss and inverter loss at a constant speed.</li> </ul>	
	Overload prevention control	<ul style="list-style-type: none"> <li>• If the ambient temperature or IGBT joint temperature increases due to overload, the inverter lowers the output frequency to avoid overload.</li> </ul>	
	Voltage Shortage Avoidance Operation	<ul style="list-style-type: none"> <li>• The continuous operation is available reducing output frequency during low voltage.</li> </ul>	
	Input Phase Loss Protection Avoidance Operation	<ul style="list-style-type: none"> <li>• Selectable from trip or continuous low power operation.</li> </ul>	
	Off-line tuning	<ul style="list-style-type: none"> <li>• Rotary type and non-rotary type are available for tuning the motor constant.</li> </ul>	
	Cooling fan ON/OFF control	<ul style="list-style-type: none"> <li>• Detects inverter internal temperature of the inverter and stops the cooling fan when the temperature is low.</li> <li>• The fan control signal can be output to an external device.</li> </ul>	
	Universal DI	<ul style="list-style-type: none"> <li>• The status of external digital signal connected with the universal digital input terminal is transferred to the host controller.</li> </ul>	
	Universal DO	<ul style="list-style-type: none"> <li>• Digital command signal from the host controller is output to the universal digital output terminal.</li> </ul>	
	Universal AO	<ul style="list-style-type: none"> <li>• The analog command signal from the host controller is output to the analog output terminal.</li> </ul>	
	Rotation direction control	<ul style="list-style-type: none"> <li>• Preventing reverse rotation</li> <li>• Preventing forward rotation</li> </ul>	
	Preventing condensation in motor	<ul style="list-style-type: none"> <li>• When the inverter is stopped, current is automatically supplied to the motor to keep the motor warm and avoid condensation.</li> </ul>	
	Customized logic interface	<ul style="list-style-type: none"> <li>• Available in 14 steps with the functions of 2-input, 1-output, logical calculation, and timer function.</li> </ul>	
	Pump control	<ul style="list-style-type: none"> <li>• Filter clogging prevention</li> <li>• Anti jam</li> <li>• Wet-bulb temperature presumption control</li> </ul>	
	Fire mode	<ul style="list-style-type: none"> <li>• Continues operation without alarm by retry.</li> </ul>	
	Pattern operation	<ul style="list-style-type: none"> <li>• Pattern operation is available by inverter itself.</li> </ul>	
	Real time clock (RTC)	<ul style="list-style-type: none"> <li>• Date, hour and alarm information with date and hour can be displayed, and timer operation can be used with RTC.</li> <li>• Daylight saving time auxiliary function.</li> </ul>	Time can be maintained with battery (option).
Timer operation	<ul style="list-style-type: none"> <li>• Set 4-timers for one week.</li> </ul>		
Password function	<ul style="list-style-type: none"> <li>• Prevent improperly operation and/or data undisplayed available. (two level setting.)</li> </ul>		
External PID control	<ul style="list-style-type: none"> <li>• PID processor for process control / On / Off controller (3 channels)</li> <li>• Normal operation / inverse operation</li> <li>• PID command: Keypad, analog input (terminals [12], [C1] and [V2]), RS-485</li> <li>• PID feedback value (terminals [12], [C1] and [V2])</li> <li>• Alarm output (absolute value alarm, deviation alarm)</li> <li>• PID feedback error detection</li> <li>• Sensor input amount scaling</li> <li>• Sensor input amount conversion / calculation</li> <li>• PID output limiter</li> <li>• Integration reset / hold</li> <li>• Anti-reset wind-up function</li> </ul>		
Display	Run/stop	Speed monitor (set frequency, output frequency, motor speed, load shaft speed, line speed, and speed indication with percent), Output current [A], output voltage [V], calculated torque [%], input power [kW], PID reference value, PID feedback value, PID output, load [%], motor output [kW], analog input monitor, integral power consumption [kWh], integral power consumption [MWh], effective current value for each phase [A]	
	Inverter life warning	<ul style="list-style-type: none"> <li>• Life judgment of the main circuit capacitor, electrolytic capacitor on printed circuit board, and cooling fan.</li> <li>• Life warning information can be output to an external device.</li> <li>• Ambient temperature : IP00/IP21 40 , IP55 30 , Load rate : inverter rated current 100%</li> </ul>	
	Cumulative running hours	<ul style="list-style-type: none"> <li>• Displays the inverter cumulative running hours, integrated power, cumulative motor running hours, and the number of operation start times.</li> <li>• Outputs the warning when the maintenance time or the number of start times has exceeded the preset value.</li> <li>• Displays the cumulative energy for unit of months, weeks, days and hours and running hours (with RTC).</li> </ul>	
	Light-alarm	<ul style="list-style-type: none"> <li>• WARN. LED is lit and light-alarm factor is displayed.</li> </ul>	
	Trip mode	<ul style="list-style-type: none"> <li>• Displays the cause of trip.</li> </ul>	
	Running or trip mode	<ul style="list-style-type: none"> <li>• Trip history : Saves and displays the cause of the last ten trips (with a code).</li> <li>• Detail data recorded : Saves and displays the detail data recorded on occurrence of the last four trips.</li> <li>• Saves and displays the date, hour and minute with RTC.</li> </ul>	
	LED display	<ul style="list-style-type: none"> <li>• LED for light-alarm or alarm occurrence.</li> </ul>	
	Guidance function	<ul style="list-style-type: none"> <li>• Needed information can be displayed by pushing "HELP" key.</li> </ul>	
	Multi language	<ul style="list-style-type: none"> <li>• Corresponded to Japanese, English, German, French, Spanish, Italian, Chinese, Russian, Greek, Turkish, Polish, Czech, Swedish, Portuguese, Dutch, Malay, Vietnamese, Thai and Indonesian. (Sequential correspond to User Customized Language.)</li> </ul>	
	Battery level display	<ul style="list-style-type: none"> <li>• Battery level can be displayed when the battery (option) is connected.</li> </ul>	
	LCD back-light	<ul style="list-style-type: none"> <li>• Set lighting time for LCD back-light during key operation only or unlit.</li> </ul>	
	Protective function	Overcurrent protection	<ul style="list-style-type: none"> <li>• The inverter is stopped for protection against overcurrent.</li> </ul>
Short-circuit protection		<ul style="list-style-type: none"> <li>• The inverter is stopped for protection against overcurrent caused by a short circuit in the output circuit.</li> </ul>	OC1,OC2,OC3
Ground fault protection		<ul style="list-style-type: none"> <li>• The inverter is stopped for protection against overcurrent caused by a grounding fault in the output circuit. (37 kW or less)</li> </ul>	
Overvoltage protection		<ul style="list-style-type: none"> <li>• An excessive voltage (800 VDC) in the DC link circuit is detected and the inverter is stopped.</li> <li>• If an excessive voltage is applied unintended, the protection can not be guaranteed.</li> </ul>	OU1,OU2,OU3
Undervoltage protection		<ul style="list-style-type: none"> <li>• The voltage drop (400 VDC) in the DC link circuit is detected to stop the inverter.</li> <li>• However, the alarm will not be issued when the re-starting after instantaneous stop is selected.</li> </ul>	LU
Input phase loss protection		<ul style="list-style-type: none"> <li>• The input phase loss is detected to protect or shut off the inverter.</li> <li>• When the load to be connected is small, a phase loss would not be detected.</li> </ul>	Lin
Output phase loss detection	<ul style="list-style-type: none"> <li>• Detects breaks in inverter output wiring at the start of running and during running and stop the inverter output.</li> </ul>	OPL	

Items		Specifications	Remarks	
Protective function	Overheat protection	<ul style="list-style-type: none"> <li>Stop the inverter output detecting excess cooling fin temperature in case of a cooling fan fault or overload.</li> <li>Stop the inverter output detecting inner temperature of the inverter unit for a cooling fan fault or overload.</li> <li>Stop the inverter output detecting the cooling fan failure.</li> <li>Stop the inverter output detecting the charging circuit fault.</li> </ul>	OH1 OH3	
	Overload protection	<ul style="list-style-type: none"> <li>Stop the inverter output detecting a switching element temperature calculated with cooling fin temperature and the output current.</li> </ul>	OLU	
	External alarm input	<ul style="list-style-type: none"> <li>With the digital input signal (THR), the inverter is stopped with an alarm.</li> </ul>	OH2	
	Motor protection	Electronic thermal	<ul style="list-style-type: none"> <li>The inverter is stopped with an electronic thermal function set to protect the motor. Protects the general-purpose motor and inverter motor over all frequency range. (The level and thermal time constant (0.5 to 75.0 min) can be set.)</li> </ul>	OL1
		PTC thermistor	<ul style="list-style-type: none"> <li>PTC thermistor input stops the inverter to protect the motor. Connect a PTC thermistor between terminal [C1] and [11] and set the switch on control print board and the function code.</li> </ul>	OH4
		Overload early warning	<ul style="list-style-type: none"> <li>Warning signal (OL) is output at the predetermined level before with electronic thermal function.</li> </ul>	—
	Memory error	<ul style="list-style-type: none"> <li>Data is checked upon power-on and data writing to detect any fault in the memory and stop the inverter if any.</li> </ul>	Er1	
	Keypad panel communications error	<ul style="list-style-type: none"> <li>The keypad panel detects a communication fault between the keypad panel and the inverter main body during the run command from the keypad panel available and to stop the inverter.</li> </ul>	Er2	
	CPU error	<ul style="list-style-type: none"> <li>Stop the inverter detecting a CPU error or LSI error caused by noise.</li> </ul>	Er3	
	Option communications error	<ul style="list-style-type: none"> <li>When each option is used, a fault of communication with the inverter main body is detected to stop the inverter.</li> </ul>	Er4	
	Option error	<ul style="list-style-type: none"> <li>When each option is used, the option detects a fault to stop the inverter.</li> </ul>	Er5	
	Operation error	<ul style="list-style-type: none"> <li> key priority : Pressing the  key on the keypad will forcibly decelerate, stop the motor and display "Er6" even if the running command through signal input or communication is selected.</li> <li>Start check : If the running command is being input when switching the running command method from power-on, alarm reset or the linked operation, the operation starts suddenly. This function prohibits running and displays "Er6".</li> </ul>	Er6	
	Tuning error	<ul style="list-style-type: none"> <li>Stop the inverter output when tuning failure, interruption or any fault as a result of tuning is detected during tuning for motor constant.</li> </ul>	Er7	
	RS-485 communications error (port1)	<ul style="list-style-type: none"> <li>Stop the inverter output detecting the communication error between the inverter main unit and a mate when the RS-485 connection port of the keypad panel is used to configure the network.</li> </ul>	Er8	
	Data save error upon undervoltage	<ul style="list-style-type: none"> <li>When the undervoltage protection occurred, an alarm is displayed if the data is not properly saved.</li> </ul>	ErF	
	RS-485 communications error (port2)	<ul style="list-style-type: none"> <li>Stop the inverter output detecting the communication error between the inverter main unit and a mate when the RS-485 connection port of the [DX+], [DX-] are used to configure the network.</li> </ul>	ErP	
	Hardware error	<ul style="list-style-type: none"> <li>Stop the inverter detecting a LSI error on the power printed circuit board caused by noise.</li> </ul>	ErH	
	Simulation error	<ul style="list-style-type: none"> <li>Simulated alarm is output by the keypad panel operation.</li> </ul>	Err	
	Current input wire break detection	<ul style="list-style-type: none"> <li>Stop the inverter detecting a analog wire break detection (enable / disable selectable).</li> </ul>	CoF	
	PID feedback error detection	<ul style="list-style-type: none"> <li>Stop the inverter output detecting a PID feedback line break. (Selectable valid/invalid.)</li> </ul>	PV1,PV2,PVA,PVb,PVC	
	Customized logic error detection	<ul style="list-style-type: none"> <li>Alarm is output detecting a customized logic setting error.</li> </ul>	ECL	
	Anti jam protection	<ul style="list-style-type: none"> <li>Display the error detecting the starting failure due to overcurrent.</li> </ul>	rLo	
	Filter clogging prevention	<ul style="list-style-type: none"> <li>Display the error detecting the overload during PID control.</li> </ul>	FoL	
	Enable circuit failure detection	<ul style="list-style-type: none"> <li>Diagnos the enable circuit condition and stop the inverter output detecting the circuit failure.</li> </ul>	ECF	
	Alarm relay output (for any fault)	<ul style="list-style-type: none"> <li>The inverter outputs a relay contact signal when the inverter issues an alarm and stops the inverter output.</li> <li>The alarm stop state is reset by pressing the  key or by the digital input signal (RST).</li> </ul>		
	Light-alarm (warning)	<ul style="list-style-type: none"> <li>Light- alarm is displayed when registered alarm or warning as light-alarm is occurred. (continuous running)</li> <li>Covered alarm : External alarm (OH2), Inverter overheat (OH3), Motor overheat (OH4), Motor overload (OL1), Keypad panel communication error (Er2), Optional communication error (Er4), Option error (Er5), RS-485 communication error (port 1)(Er8), RS-485 communication error (port 2)(ErP), DC fan lock detected, Overload early warning (for motor), Heatsink overheat early warning, Life early warning (DC link bus capacitor, electrolytic capacitor on printed circuit board, cooling fan), Reference command loss detected, PID warning output, Low torque detected, Thermistor detection (PTC), Machine life (cumulative motor run time error), Machine life (number of startups error), Current Input Wire Break Detection, PID feedback error detection, Low battery warning, Date&amp;time information lost,</li> </ul>		
	Stall prevention	<ul style="list-style-type: none"> <li>Operates when the inverter output goes beyond the instantaneous overcurrent limiting level, and avoids tripping, during acceleration and constant speed operation.</li> </ul>		
	Retry function	<ul style="list-style-type: none"> <li>When the motor is tripped and stopped, this function automatically resets the tripping state and restarts operation. (Retry times, waiting time for reset, corresponding trip for retry and retry available time can be set.) It can be confirmed by communication the times of the restarting.</li> </ul>		
	Surge protection	<ul style="list-style-type: none"> <li>The inverter is protected against surge voltage intruding between the main circuit power line and ground.</li> </ul>		
	Command loss detected	<ul style="list-style-type: none"> <li>A loss (breaking, etc.) of the frequency command is detected to output an alarm and the operation is continued at the preset frequency (set at a ratio to the frequency before detection).</li> </ul>		
Momentary power failure protection	<ul style="list-style-type: none"> <li>If restart upon momentary power failure is selected, the inverter restarts upon recovery of the voltage within the set time.</li> </ul>			
Environment	Installation location	<ul style="list-style-type: none"> <li>Free from corrosive gases, flammable gases, dusts, oil mist, direct sunlight. (Pollution degree 2 (IEC60664-1)). Indoor use only.</li> </ul>		
	Ambient temperature	IP21	<ul style="list-style-type: none"> <li>-10 to +50 (+50 to +60 : correspond with deleting)</li> <li>(-10 to +40 : installed side-by-side without clearance (37 kW or less))</li> </ul>	
		IP55	<ul style="list-style-type: none"> <li>-10 to +40 (+40 to +50 : correspond with deleting)</li> <li>(-10 to +30 : installed side-by-side without clearance (37 kW or less))</li> </ul>	
		IP00	<ul style="list-style-type: none"> <li>-10 to +50</li> </ul>	
	Ambient humidity	<ul style="list-style-type: none"> <li>5 to 95 %RH (without condensation)</li> </ul>		
	Altitude	<ul style="list-style-type: none"> <li>1,000m or lower</li> </ul>		
	Vibration	<ul style="list-style-type: none"> <li>90kW or less : 2 to less than 9 Hz</li> <li>3mm : 2 to less than 9 Hz</li> <li>10m/s<sup>2</sup> : 9 to less than 200Hz</li> <li>110 to 710kW : 2 to less than 9 Hz</li> <li>3mm : 2 to less than 9 Hz</li> <li>2m/s<sup>2</sup> : 9 to less than 55Hz</li> <li>1m/s<sup>2</sup> : 55 to less than 200Hz</li> </ul>		
	Storage temperature	<ul style="list-style-type: none"> <li>-25 to +70</li> </ul>		
Storage humidity	<ul style="list-style-type: none"> <li>5 to 95 %RH (without condensation)</li> </ul>			

\*1 Detection of all circuit failures is not guaranteed (EN ISO 13849-1 Cat.3 compliant).

\*2 Alarm (ECF) is occurred when one of the inputs of EN1 or EN2 are OFF (if it exceeds 50 ms, it will be as disagreement.). Power supply reboot only to reset this alarm.

\*3 Apply by wire to turn off enable command and stop the inverter output with feedback signal assigned DECF signal of inverter

## How to read the model number

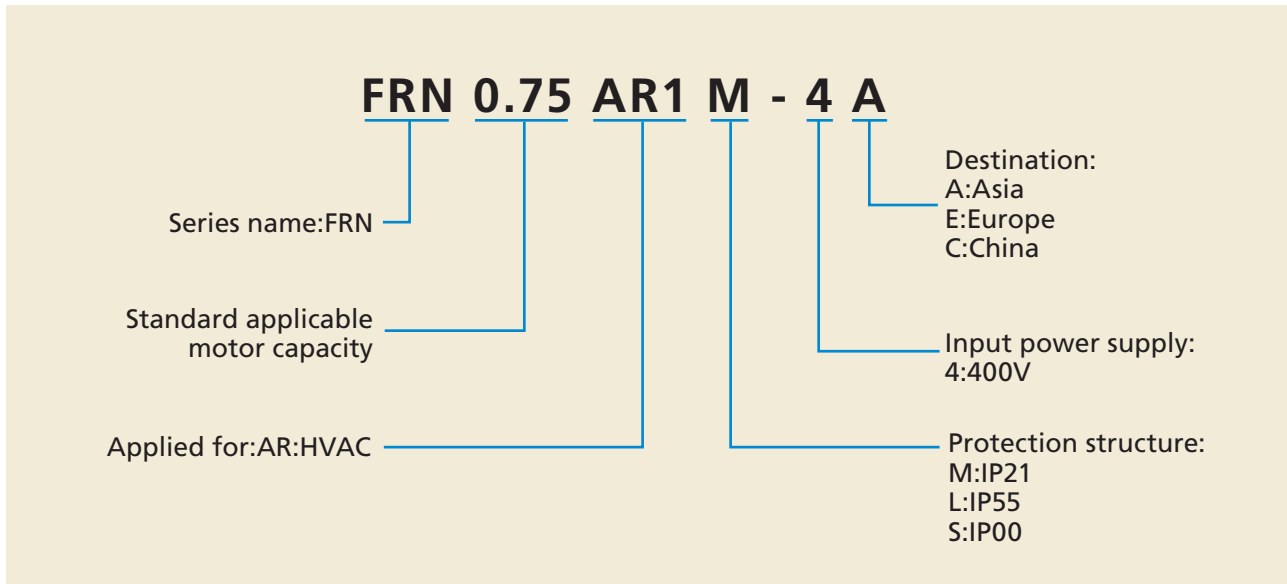

## Model variation

Destination	Rated voltage	Nominal applied motor	Type	Outside dimensions (mm)					Mounting dimensions (mm)								
				Dwg.no.	W	H	D	D1	D2	Dwg.no.	W1	W2	H1	H2	H3	M	N
Europe /Asia/China (E/A/C)	3-phase 400V	0.75	FRN0.75AR1□-4#	A	150	465	262	162	100	B	115	17.5	451	7	-	2xφ8	8
		1.5	FRN1.5AR1□-4#														
		2.2	FRN2.2AR1□-4#														
		3.7	FRN3.7AR1□-4#														
		5.5	FRN5.5AR1□-4#														
		7.5	FRN7.5AR1□-4#														
		11	FRN11AR1□-4#														
		15	FRN15AR1□-4#														
		18.5	FRN18.5AR1□-4#														
		22	FRN22AR1□-4#														
		30	FRN30AR1□-4#	C	265	736	284	184.5	99.5	D	180	42.5	716	12	8	2xφ10	10
		37	FRN37AR1□-4#														
		45	FRN45AR1□-4#														
		55	FRN55AR1□-4#	E	530	740	315	135	180	F	430	50	710	15.5	14.5	2xφ15	15
		75	FRN75AR1□-4#														
		90	FRN90AR1□-4#	G	680	1000	360	180	180	H	290	50	970	15.5	14.5	3xφ15	15
		110	FRN110AR1□-4#														
		132	FRN132AR1□-4#														
		160	FRN160AR1□-4#														
		200	FRN200AR1□-4#														
		220	FRN220AR1□-4#														
280	FRN280AR1□-4#	I	880	1400	440	260	180	J	260	50	1370	15.5	14.5	4xφ15	15		
315	FRN315AR1□-4#																
355	FRN355AR1□-4#																
400	FRN400AR1□-4#																
500	FRN500AR1□-4#																
630	FRN630AR1□-4#	I	1000	1550	500	313.2	186.8	J	300	49.5	1520	15.5	14.5	4xφ15	15		
710	FRN710AR1□-4#																

□(Protective structure) : M : IP21, L : IP55(0.75 to 90kW), S : IP00(110 to 710kW)  
# (Destination) : A : Asia, E : Europe, C : China



## Outline drawing

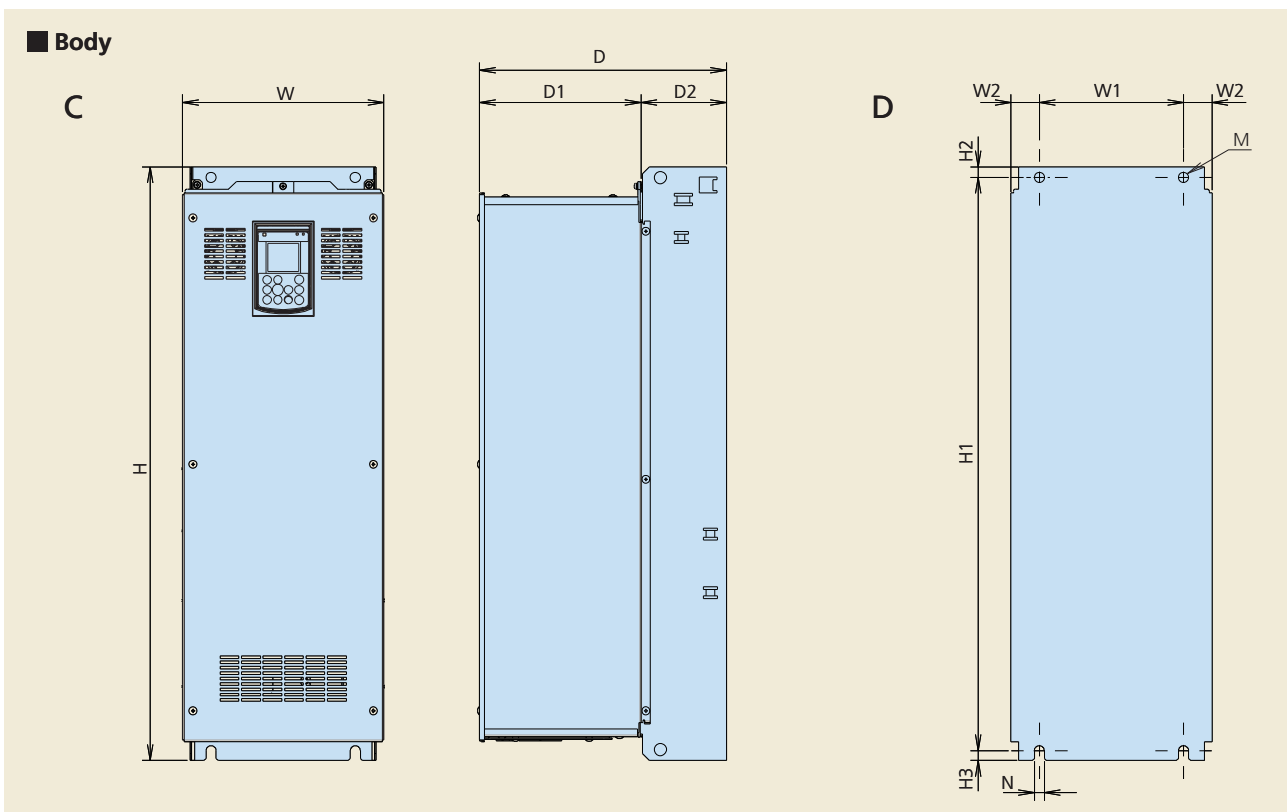
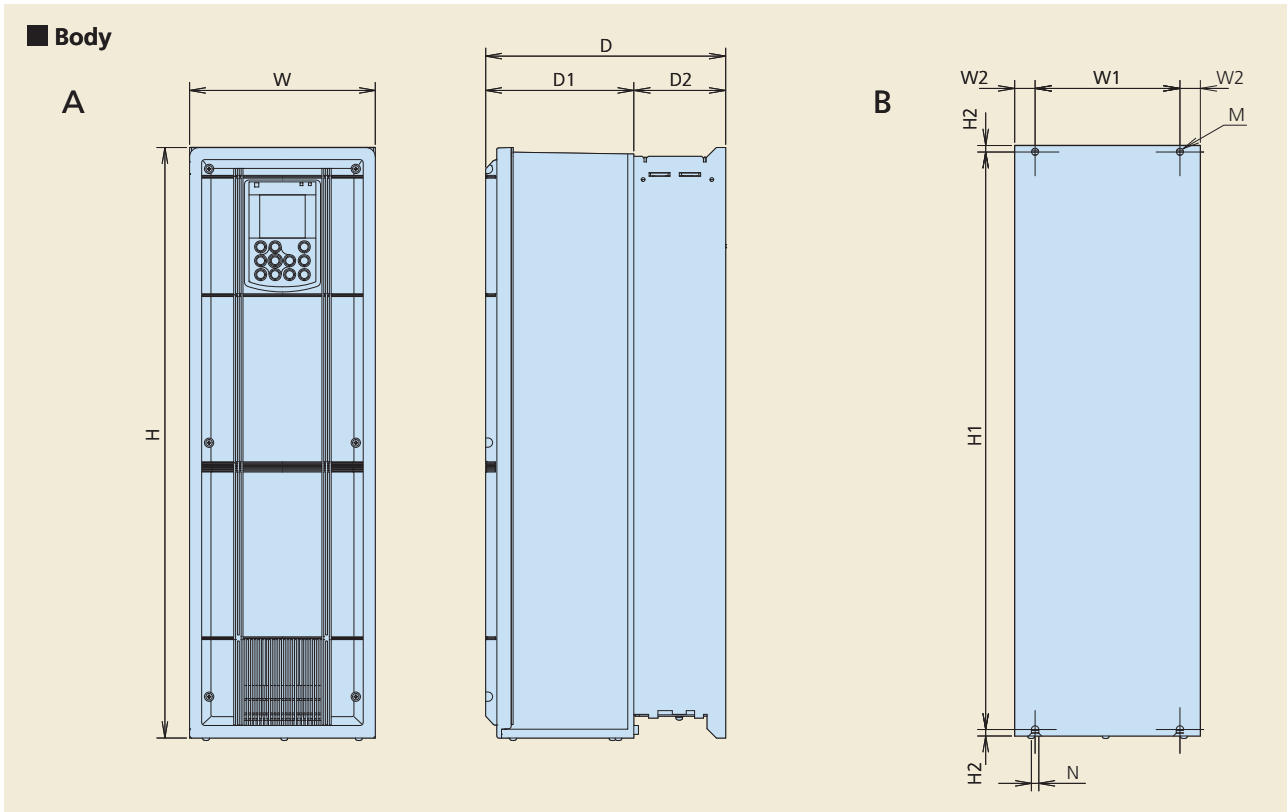

## Outline drawing

### Body

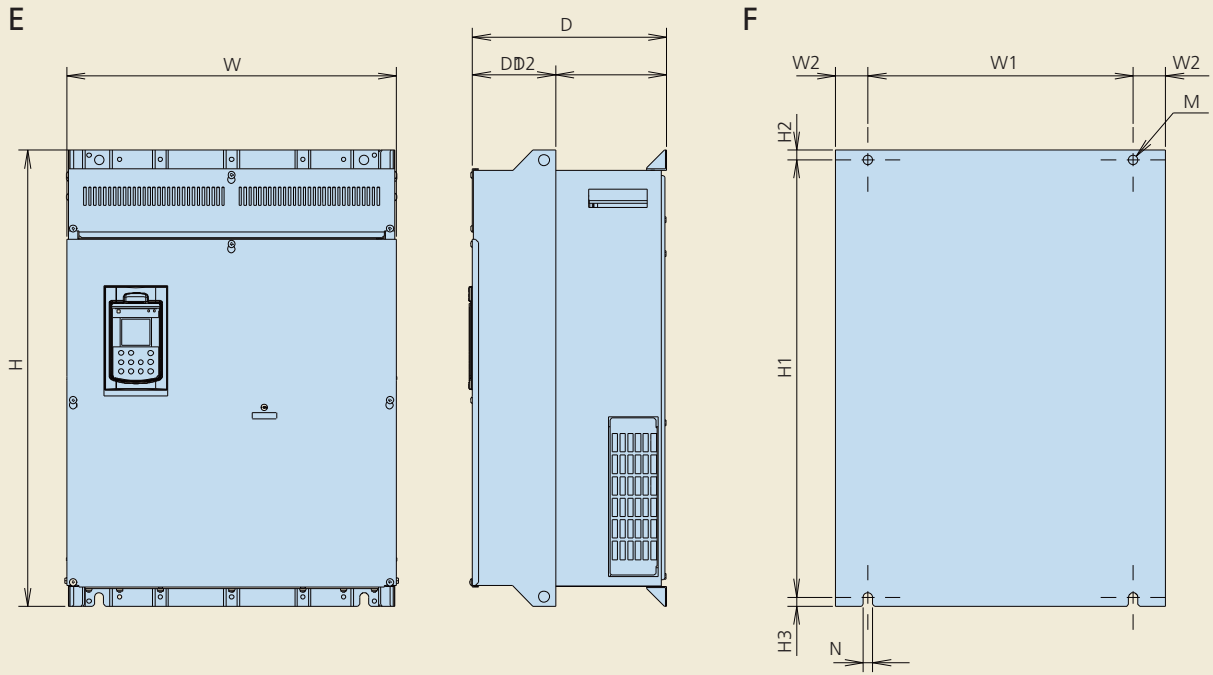

### Body

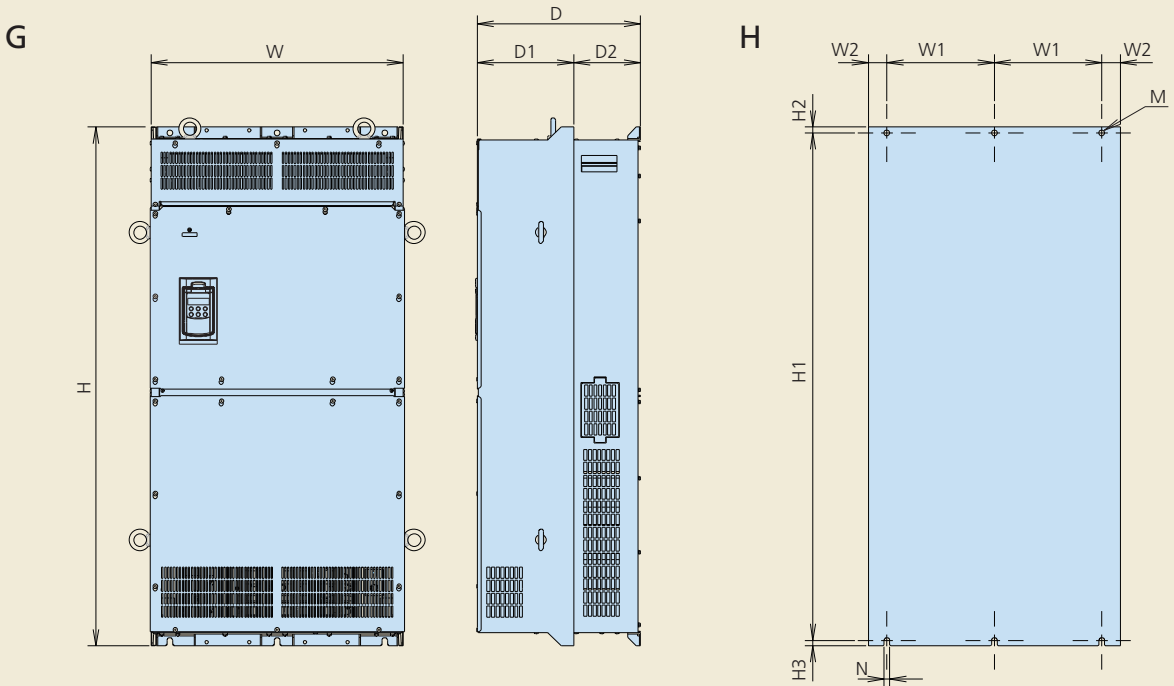

## Outline drawing

### Body

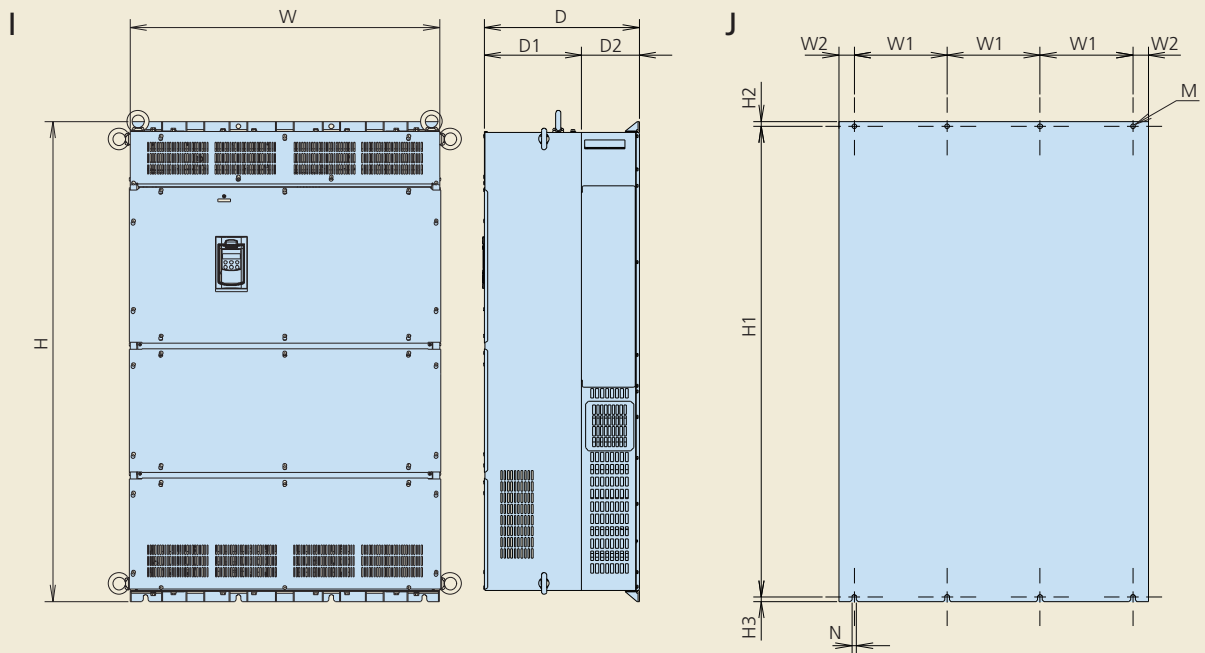

### Keypad

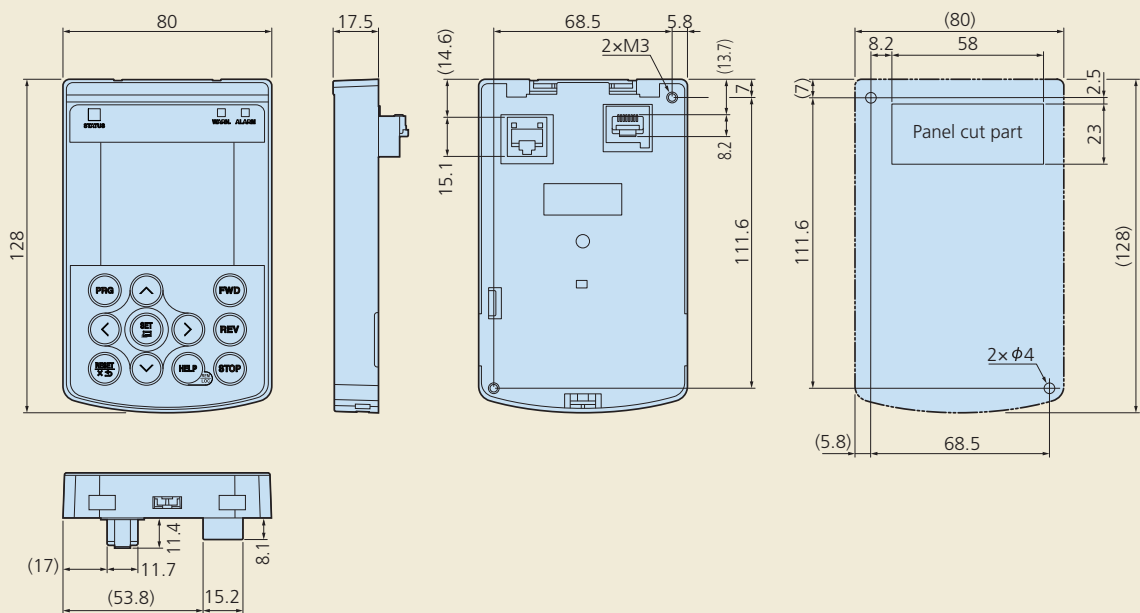



# Wiring Diagram

## Basic configuration diagram

(Factory shipped condition: with SINK mode input and enable input function)

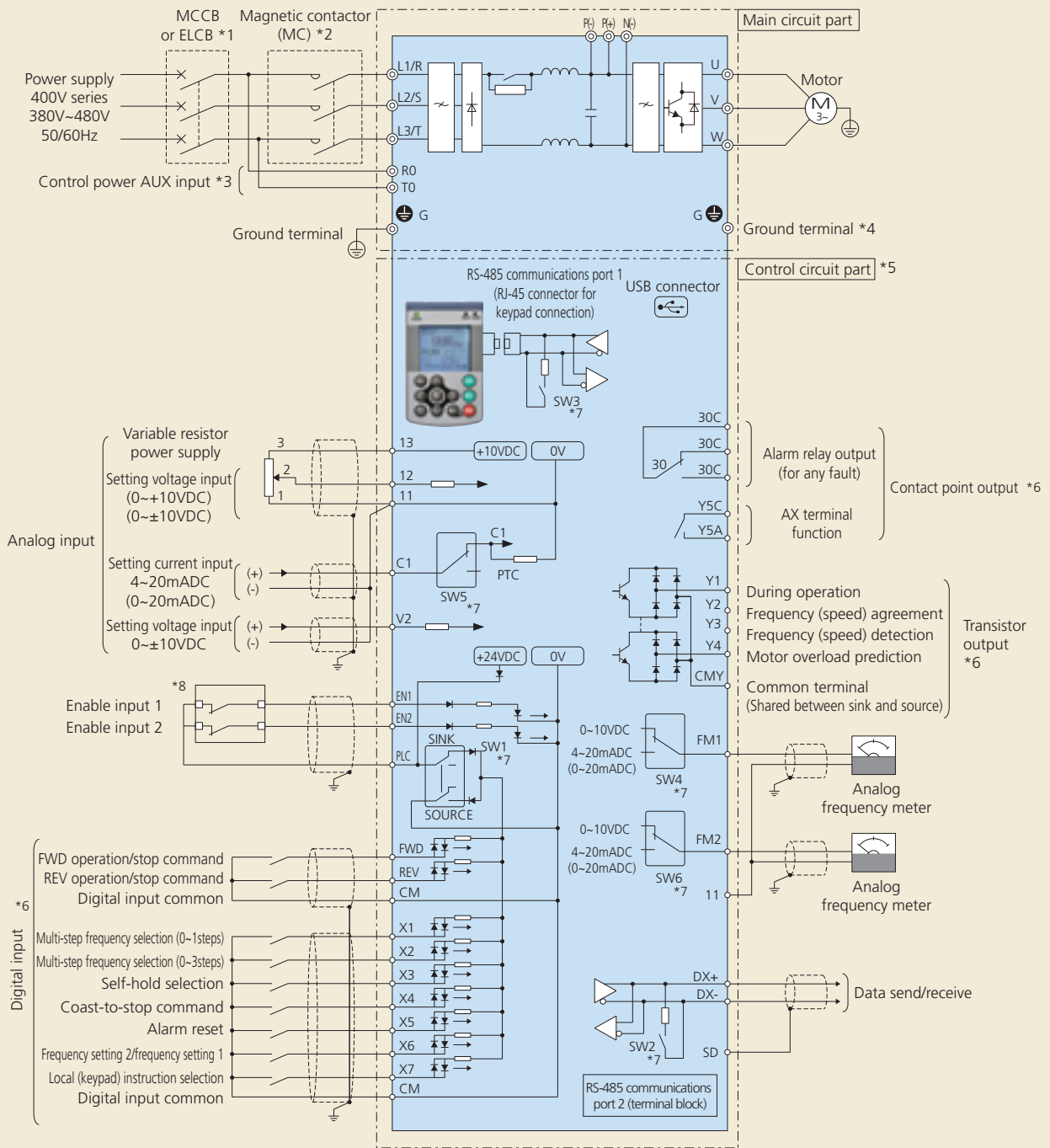

### Basic configuration diagram

(Factory shipped condition: with SOURCE mode input and enable input function)

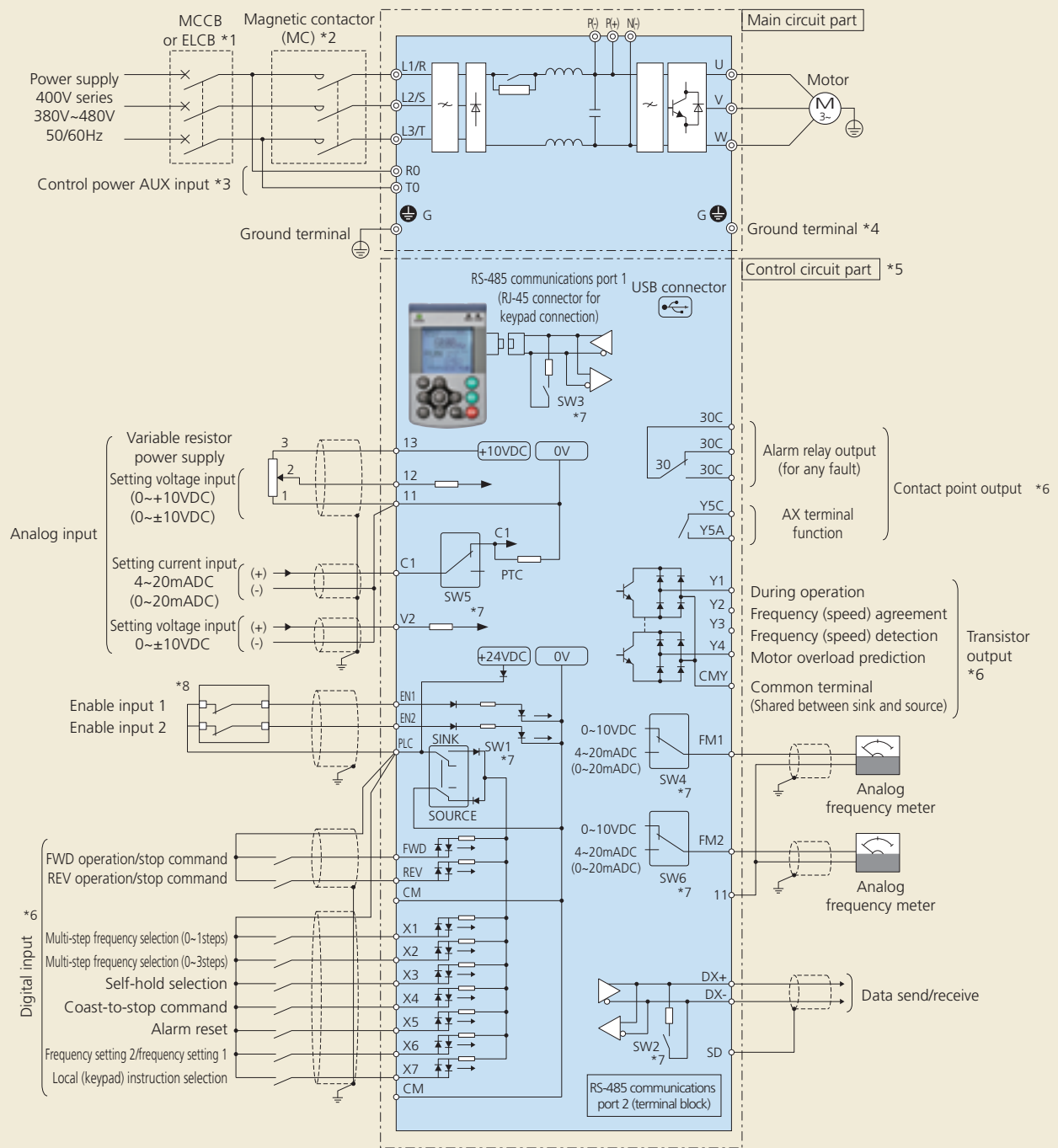

## Options

### Relay output interface card (OPC-RY)

This is an optional card that converts the transistor output at terminals Y1 to Y4 on the inverter body to relay output (1c). Each card has two relay outputs, and four relay outputs are available by installing two cards.

Note: When the card is mounted, the terminals Y1 to Y4 on the inverter body

<b>Relay output:</b>	2 circuits built-in
<b>Signal type:</b>	1c
<b>Contact point capacity:</b>	AC250V, 0.3A $\cos\phi=0$ . DC48V, 0.5A (Resistance load)

### Relay output interface card (OPC-RY2)

This optional card allows relay outputs (1a) to be added. When used in cascaded control, this card can control the seven motors.

\* By using the two relay outputs on the inverter body, max. 8 units and one unit (auxiliary pump) can be controlled.

<b>Relay output:</b>	7 circuits built-in
<b>Signal type:</b>	1a
<b>Contact point capacity:</b>	AC250V, 0.3A $\cos\phi=0$ . DC48V, 0.5A (Resistance load)

### Analog input interface card (OPC-AIO)

This card allows analog input and output to be used.

<b>Analog input:</b>	1 analog voltage input point (0~±10V) 1 analog current input point (4~20mA)
<b>Analog output:</b>	1 analog voltage output point (0~±10V) 1 analog current output point (4~20mA)

### Analog current output interface card (OPC-AO)

This card allows two analog current output (4 to 20mA) points to be used. The card cannot be used together with OPC-G1-AIO.

### CC-Link communications card (OPC-CCL) Coming soon

By connecting this card with the CC-Link master unit, the communications rate up to 10Mbps can be supported and the transmission distance is covered up to 1200 m in total.

<b>No. of connection units:</b>	42 units
<b>Communications method:</b>	CC-Link Ver1.10 and Ver2.0
<b>Communications rate:</b>	156kbps~

### DeviceNet communications card (OPC-DEV) Coming soon

This card enables operation instruction and frequency command to be set from the DeviceNet master, allowing operation conditions to be monitored and all the function codes to be changed and checked.

<b>No. of connection nodes:</b>	max. 64 units (including the master unit)
<b>MAC ID:</b>	0~63
<b>Insulation:</b>	500V DC (photocoupler insulation)
<b>Communications rate:</b>	500kbps/250kbps/125kbps
<b>Network consumed power:</b>	max. 80mA, 24V DC

## PROFIBUS DP communications card (OPC-PDP2) Coming soon

This card enables operation instruction and frequency command to be set from the PROFIBUS DP master, allowing operation conditions to be monitored and all the function codes to be changed and checked.

**Communications rate:** 9.6kbps~12Mbps  
**Transmission distance:** ~1,200m  
**Connection connector:** 2×6-pole terminal block

## CANopen communications card (OPC-COP) Coming soon

This card enables operation instruction and frequency command to be set from the CANopen master (such as PC and PLC), allowing all the function codes to be set and checked.

**No. of connection nodes:** 127 units  
**Communications rate:** 20k, 50k, 125k, 250k, 500k, 800k, 1Mbps  
**Transmission distance:** ~2,500m

## LonWorks communications card (OPC-LNW) Coming soon

This card allows peripheral equipment (including a master unit) that is connected via LonWorks to be connected with the inverter, enabling operation instruction and frequency command to be set from the master unit.

## Ethernet communications card Coming soon

This is an interface card for connecting FRENIC-HVAC with peripherals (such as a master) via Ethernet.

## Pt100 temperature sensor input card (OPC-PT) Coming soon

This card can connect FRENIC-HVAC with a mountable two-channel resistance temperature detector (hereinafter-called RTD) to convert temperature values into digital values.

The following five types of mountable RTU are supported: JPt100, Pt100, Ni100, Pt1000, and Ni1000.

## Battery Coming soon

Used for the real time clock activated while the inverter power is off. The real time clock can be operated even when no power is supplied inverter at electric power interruption.

## Extension cable for remote operation (CB-□S)

This cable is used in connection between the inverter body and the keypad.

Optional type	Length (m)
CB-5S	5
CB-3S	3
CB-1S	1





**MEMO**

---

 MEMO

---



## NOTES

### When running general-purpose motors

#### • Driving a 400V general-purpose motor

When driving a 400V general-purpose motor with an inverter using extremely long cables, damage to the insulation of the motor may occur. Use an output circuit filter (OFL) if necessary after checking with the motor manufacturer. Fuji's motors do not require the use of output circuit filters because of their reinforced insulation.

#### • Torque characteristics and temperature rise

When the inverter is used to run a general-purpose motor, the temperature of the motor becomes higher than when it is operated using a commercial power supply. In the low-speed range, the cooling effect will be weakened, so decrease the output torque of the motor. If constant torque is required in the low-speed range, use a Fuji inverter motor or a motor equipped with an externally powered ventilating fan.

#### • Vibration

When the motor is mounted to a machine, resonance may be caused by the natural frequencies, including that of the machine. Operation of a 2-pole motor at 60Hz or more may cause abnormal vibration.

\* Study use of tier coupling or dampening rubber.

\* It is also recommended to use the inverter jump frequency control to avoid resonance points.

#### • Noise

When an inverter is used with a general-purpose motor, the motor noise level is higher than that with a commercial power supply. To reduce noise, raise carrier frequency of the inverter. High-speed operation at 60Hz or more can also result in more noise.

### When running special motors

#### • Explosion-proof motors

When driving an explosion-proof motor with an inverter, use a combination of a motor and an inverter that has been approved in advance.

#### • Brake motors

For motors equipped with parallel-connected brakes, their braking power must be supplied from the primary circuit (commercial power supply). If the brake power is connected to the inverter power output circuit (secondary circuit) by mistake, problems may occur.

Do not use inverters for driving motors equipped with series-connected brakes.

#### • Geared motors

If the power transmission mechanism uses an oil-lubricated gearbox or speed changer/reducer, then continuous motor operation at low speed may cause poor lubrication. Avoid such operation.

#### • Single-phase motors

Single-phase motors are not suitable for inverter-driven variable speed operation. Use three-phase motors.

### Environmental conditions

#### • Installation location

Use the inverter in a location with an ambient temperature range of -10 to 50°C.

The inverter and braking resistor surfaces become hot under certain operating conditions. Install the inverter on nonflammable material such as metal.

Ensure that the installation location meets the environmental conditions specified in "Environment" in inverter specifications.

### Combination with peripheral devices

#### • Installing a molded case circuit breaker (MCCB)

Install a recommended molded case circuit breaker (MCCB) or an earth leakage circuit breaker (ELCB) in the primary circuit of each inverter to protect the wiring. Ensure that the circuit breaker capacity is equivalent to or lower than the recommended capacity.

#### • Installing a magnetic contactor (MC) in the output (secondary) circuit

If a magnetic contactor (MC) is mounted in the inverter's secondary circuit for switching the motor to commercial power or for any other purpose, ensure that both the inverter and the motor are fully stopped before you turn the MC on or off. Remove the surge killer integrated with the MC.

#### • Installing a magnetic contactor (MC) in the input (primary) circuit

Do not turn the magnetic contactor (MC) in the primary circuit on or off more than once an hour as an inverter fault may result. If frequent starts or stops are required during motor operation, use FWD/REV signals.

#### • Protecting the motor

The electronic thermal facility of the inverter can protect the general-purpose motor. The operation level and the motor type (general-purpose motor, inverter motor) should be set. For high-speed motors or water-cooled motors, set a small value for the thermal time constant to protect the motor.

If you connect the motor thermal relay to the motor with a long cable, a high-frequency current may flow into the wiring stray capacitance. This may cause the relay to trip at a current lower than the set value for the thermal relay. If this happens, lower the carrier frequency or use the output circuit filter (OFL).

#### • Discontinuance of power-factor correcting capacitor

Do not mount power factor correcting capacitors in the inverter (primary) circuit. (Use the DC REACTOR to improve the inverter power factor.) Do not use power factor correcting capacitors in the inverter output circuit (secondary). An overcurrent trip will occur, disabling motor operation.

#### • Discontinuance of surge killer

Do not mount surge killers in the inverter output (secondary) circuit.

#### • Reducing noise

Use of a filter and shielded wires are typical measures against noise to ensure that EMC Directives are met.

#### • Measures against surge currents

If an overvoltage trip occurs while the inverter is stopped or operated under a light load, it is assumed that the surge current is generated by open/close of the phase-advancing capacitor in the power system.

We recommend connecting a DC REACTOR to the inverter.

#### • Megger test

When checking the insulation resistance of the inverter, use a 500V megger and follow the instructions contained in the Instruction Manual.

### Wiring

#### • Wiring distance of control circuit

When performing remote operation, use the twisted shield wire and limit the distance between the inverter and the control box to 20m.

#### • Wiring length between inverter and motor

If long wiring is used between the inverter and the motor, the inverter will overheat or trip as a result of overcurrent (high-frequency current flowing into the stray capacitance) in the wires connected to the phases. Ensure that the wiring is shorter than 50m. If this length must be exceeded, lower the carrier frequency or mount an output circuit filter (OFL).

When wiring is longer than 50m, and sensorless vector control or vector control with speed sensor is selected, execute off-line tuning.

#### • Wiring size

Select cables with a sufficient capacity by referring to the current value or recommended wire size.

#### • Wiring type

Do not use multicore cables that are normally used for connecting several inverters and motors.

#### • Grounding

Securely ground the inverter using the grounding terminal.

### Selecting inverter capacity

#### • Driving general-purpose motor

Select an inverter according to the applicable motor ratings listed in the standard specifications table for the inverter. When high starting torque is required or quick acceleration or deceleration is required, select an inverter with a capacity one size greater than the standard.

#### • Driving special motors

Select an inverter that meets the following condition: Inverter rated current > Motor rated current.

### Transportation and storage

When transporting or storing inverters, follow the procedures and select locations that meet the environmental conditions that agree with the inverter specifications.